

AFI presents
THE GENERATION

SIRENA

MULTILAB CENTRIFUGES 0.6l

From Experience comes Excellence



2023



UNIQUE FRENCH MANUFACTURER

AFI Centrifuge, the only French manufacturer based in Château-Gontier in FRANCE, has been designing and manufacturing innovative centrifuges since 2009. AFI centrifuges have been designed to meet the needs and requirements of medical analysis laboratories, research laboratories, veterinary laboratories, hospitals, etc.

Offering a wide variety of rotors and accessories, the user will have at his disposal all the solutions to meet the required protocols. Available in both ventilated and refrigerated versions, AFI centrifuges are designed to be used with all types of tubes, vials and bottles available on the market.

With more than 20 years of experience in the field of biomedical engineering, electronics and electromechanics, AFI presents today a wide range of versatile and innovative centrifuges

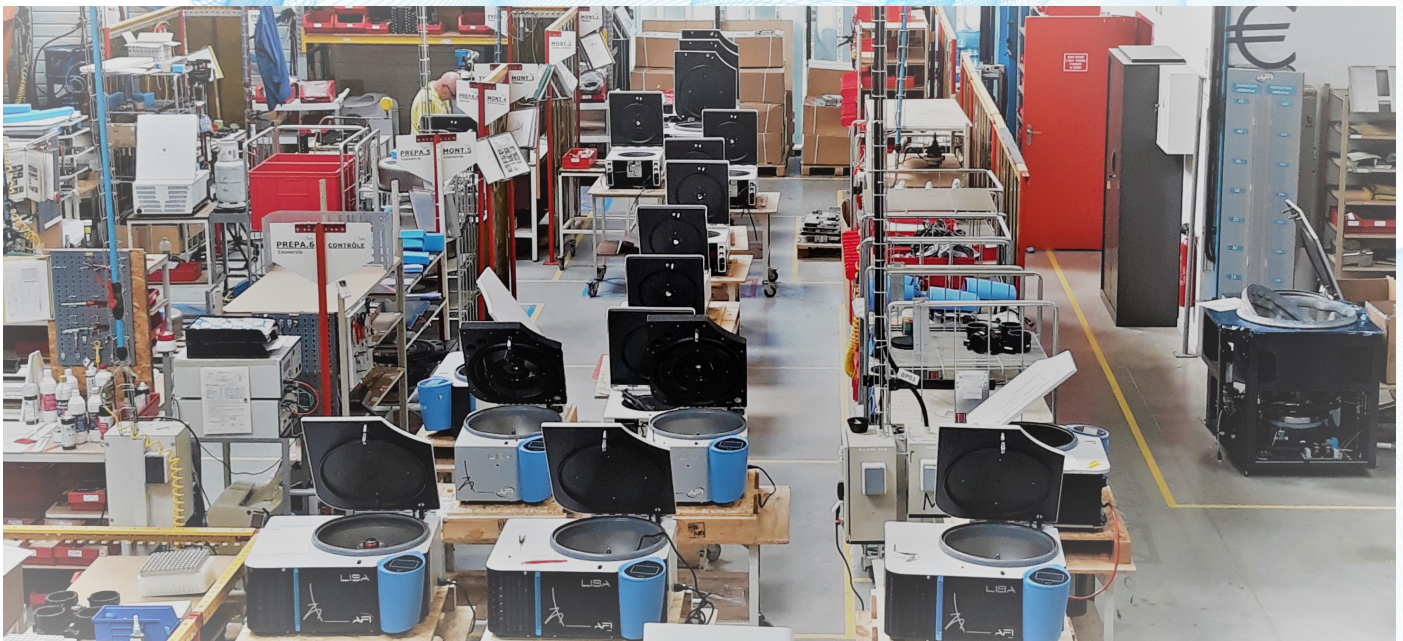

Philippe LE GUYADER



CENTRIFUGES RANGE



LIA
Micro Centrifuges*
Mini, Micro & Labo

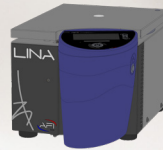

LINA
Research Centrifuge
Micro & multifonction



SIRENA
Centrifuge **MultiLab**
0.6 L

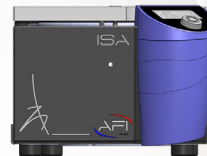

ISA
Clinical centrifuge
0.6 L

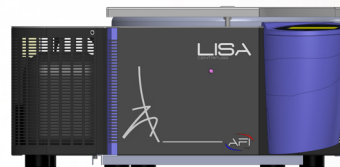

LISA
Centrifuge **MultiLab**
1.0 L à 2.5 L

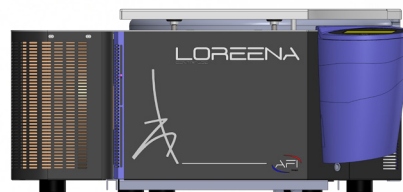

LOREENA
Centrifuge **MultiLab**
1.6 L à 4 L



KATRINA
High Capacity Centrifuge
12 L

REGINA
High Capacity Centrifuge
16 L

LIA

Rotor 24 micro tubes
15 000 Rpm/ 21 380 x g
Ventilated & Refrigerated
8 rotors

LINA

Rotor 48 micro tubes
Rotor 6x 50mL
Rotor 6 Micro plates
23 000 Rpm/ 39 625x g
Ventilated & Refrigerated
11 rotors

SIRENA

24-36 tubes 5/7 mL
6x 100mL
18 000 Rpm/ 31514 x g
Refrigerated
Interactive display
Touch screen, 99 programs,
17 rotors

ISA

40 tubes 5/7 mL
6700 Rpm/ 6324 xg
Ventilated & Refrigerated
Touch Screen, 99 programs,
11 rotors

Micro
Research centers / Veterinaire



Performance
Research centers/ Universities

Compact
Small laboratories



High Capacity
Blood bank / Industry



KATRINA

12 Liters

4900 Rpm/ 7301 x g

Refrigerated Floor

Interactive communication, Touch screen,
Integral, 6 Rotors



LOREENA

108- 200 tubes 5/7 mL / 12x 50 mL

16000 Rpm/ 28 335x g

Ventilated & Refrigerated & Floor

Interactive communication,
Click Spin, Touch Screen,
15 Rotors



LISA

60-92 tubes 5-7 mL/ 8x100mL

18 000 Rpm/ 31514 x g

Ventilated & Refrigerated

Interactive Communication, Click Spin, Touch
Screen, 18 Rotors

Routine
Hospitals/ Medical analysis Laboratories

Groups

SIRENA

Multilab Centrifuge PERFORMANCE-LINE

LOOK FUTURIST

Only SIRENA, with its offbeat look, its extraordinary display contrast and its touch screen, will be able to transport you to the future. To infinity and beyond!

SIRENA, WE KEEP IN EYE

Only SIRENA, by its blue OK, will confirm that your sample is under control: cold, speed, are respected. Only SIRENA by its green or red circles will tell you whether the cycle is running smoothly or not. You will be notified at more than 7 meters. Only SIRENA with its intuitive flashing symbols will detect the failure and show you the solution.

PERFORMANCE

Only SIRENA with its wide range of rotors (more than 13 angular rotors) will be your ally for all your research: From microbiology to molecular research and biochemistry, it will provide you with the most efficient solution.



Centrifuge Description

AFI-C060R-E	SIRENA Centrifuge Refrigerated	
Specifications	Swing-out rotor	Angular Rotor
Max Speed	4700rpm	18000rpm
Max RCF	3725g	31594g
Max Loading	4x150ml	8x100ml
T° Range	-10°C/+40°C	
Dim. (HxWxD)	29x44x72cm	
Pack dim.	47x52x81cm	
Weight	70kg	

Our best performance research centrifuge

CLICK SPIN



The Best flexibility system to change accessories without tool

INTERNATIONAL AUTOMATIC ELECTRICAL CORRECTION



International automatic correction of the electrical network. Guarantees stability of the machine's performance.

PERFORMANCE



With its wide range of rotors (more than 13 angular rotors) SIRENA provide you the most efficient solution for your research protocols.

Its major assets

6 reasons

to choose it



Updating centrifuges by a simple USB connection on the front panel.

USB CONNECTION

Centrifuge's electronic functions integrated into a front central unit. Plug & play system guaranteeing a fast and efficient intervention

UNIQUE ELECTRONIC FUNCTIONS



With its unique illuminated displays, visible at 7 meters, SIRENA will monitor your samples.

Its blue circle and OK, its green circle or blinkind red circle confirm whether or not the cycle is running smoothly. Launch your protocols with peace of mind.

INTERACTIVE ILLUMINATED DISPLAY

Swinging bucket rotors

Accessories selection guide

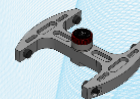

SIRENA ACCESSORIES	RX150			RHDW-150
--------------------	-------	--	--	----------



SIRENA ACCESSORIES	AFI-B150	AFI-SB150	AFI-DB50	AFI-BHDW-150
Max Capacity (ml)	4x150	4x150	8x50	8 Microplates
Max charge (gr)	260	260	2x67	725
Max Speed (rpm)	4 700	4 700	4 700	4 700
Max RCF (g)	3 704	3 729	3 754	2 964
Cavity dim (∅xD) or (WxLxD)	∅51x97	52x52x97	∅30x70	
Lid	✓	✓		✓
LISA Compatible*	✓	✓	✓	✓

* Compatible with the maximum speed written above the rotor.

Tubes	ml	∅ x L	AFI-B150	AFI-SB150	AFI-DB50	AFI-BHDW-150
	1,1-1,4	8x82	32	36	24	-
	1,5-2	11x38	48	72	24	-
	1,5-2	12,5x40	32	36	24	-
	1,3	10x45	32	36	24	-
	1,6-7	13x75-100	24	36	8	-
	2,6-4,9	13x81-106	24	36	8	-
	1,2-5	11x82-108	24	36	8	-
	4-8,5	15x91-108	16	24	8	-
	7-10	16x100	16	24	8	-
	10	21x90	12	16	8	-
	15	17x120	8	8	8	-
	30	25x110	4	4	8	-
	30	25x110	4	4	8	-
	30	25x95	4	4	8	-
	50	29x115	4	4	8	-
	50	29x115	4	4	8	-
	50 OAK	29x107	4	4	8	-
	80 OAK 85 OAK	38x106	4	4	8	-
	Micro Plates		-	-	-	8
	Deep Well		-	-	-	2

* Unsealed

AFI RX150

Adapters selection guide



AFI-B150 : ROUND BUCKETS

Model	R
Max Capacity	4 x 150ml
Angle	90°
RPM Max	4 700
ACR Max	3 704

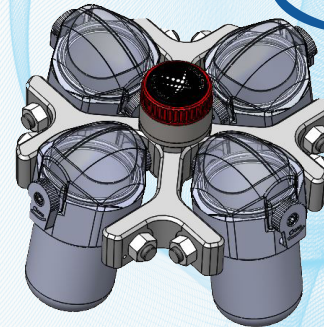

Accessories



Ref.	AFI-RX150	AFI-B150*	AFI-L150*	AFI-SB150*	AFI-LSB150*	AFI-DB50*
------	-----------	-----------	-----------	------------	-------------	-----------

* Set of 4

Tubes

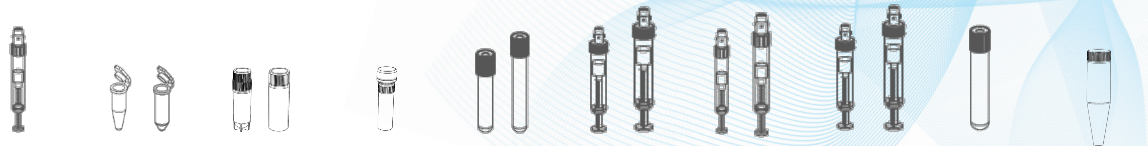

Capacity (ml)	1,1-1,4	1,5-2	1,5-2	1,3	1,6-7	2,6-4,9	1,2-5	4-8,5	7-10	10
∅ x L (mm)	8x82	11x38	12,5x40	10x45	13x75 100	13x81 106	11x82 108	15x91 108	16x100	21x90
Tubes per adapter / rotor	8 32	12 48	8 32	9 36	6 24		8 32	4 16		3 12
Adapter										
Hole ∅ x L (mm)	9x50	11,25x40	13x30	11x40	13,5x58		12,5x55	17x58		22x80
Radius	150	145	125	143	148		140	148		150
Max charge (gr)	260									
Ref.	AFI-06T1	AFI-06T2	AFI-06T2CRYO	AFI-06T1.3	AFI-06T5*		AFI-06T5ST*	AFI-06T10		AFI-06T10C

* For tube length > 80mm and ACR > 3000g, we preconise using adapter AFI-06T6 or AFI-06T6ST

Tubes

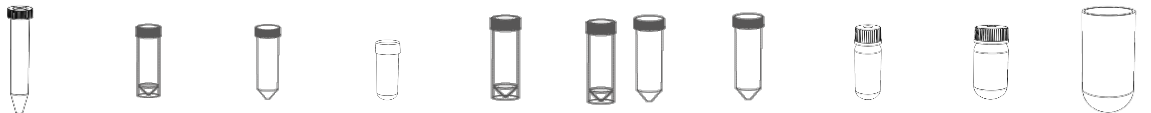

Capacity (ml)	15	30	30	30	50	50	50	50	80 / 85	100
∅ x L (mm)	17x120	25x110	25x110	25x95	29x115	29x115	29x115	29x107	38x106	44x100
Tubes per adapter / rotor	2 8	1 4	1 4	1 4	1 4	1 4	1 4	1 4	1 4	1 4
Adapter										
Hole ∅ x L (mm)	18x80	26x60	26x60	26,5x70	30x70	30x70	30x70	30x70	40x78	46x90
Radius	150	148	147	148	149	150	150	149	149	148
Max charge (gr)	260									
Ref.	AFI-06T15C	AFI-06T30S	AFI-06T30C	AFI-06T30AOR	AFI-06T50S	AFI-06T50CS*	AFI-06T50C	AFI-06T50AOR	AFI-06T80AOR	AFI-06T100

* For protocols < 3500g

AFI RX150

Adapters selection guide

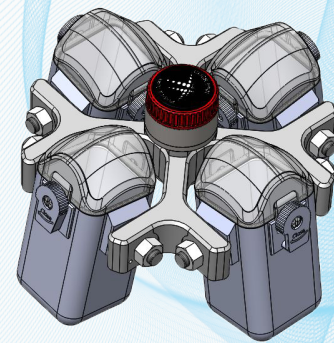

AFI-SB150 : SQUARE BUCKETS

Model	R
Max Capacity	4 x 150ml
Angle	90°
RPM Max	4 700
ACR Max	3 729

Accessories



Ref.	AFI-RX150	AFI-B150*	AFI-L150*	AFI-SB150*	AFI-LSB150*	AFI-DB50*
------	-----------	-----------	-----------	------------	-------------	-----------

* Set of 4

Tubes

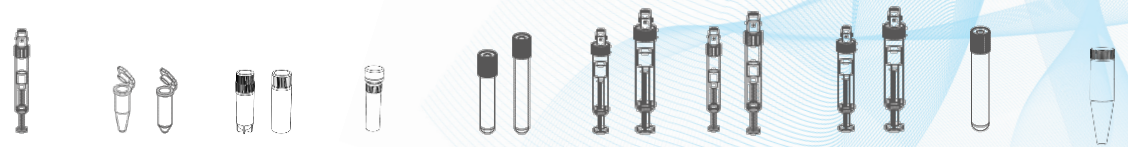

Capacity (ml)	1,1-1,4	1,5-2	1,5-2	1,3	1,6-7	2,6-4,9	1,2-5	4-8,5	7-10	10
Ø x L (mm)	8x82	11x38	12,5x40	10x45	13x75 100	13x81 106	11x82 108	15x91 108	16x100	21x90
Tubes per adapter / rotor	9 36	18 72	9 36	9 36	9 36		9 36	6 24		4 16
Adapter										
Hole Ø x L(mm)	9x50	11,25x40	13x30	11x40	13,5x58		12,5x55	17x58		22x80
Radius	151	145	90 145	125	148		146	148		150
Max charge (gr)	260									
Ref.	AFI-06T1-SB	AFI-06T2-SB	AFI-06T2CRYO-SB	AFI-06T1.3-SB	AFI-06T5-SB*		AFI-06T5ST-SB	AFI-06T10-SB		AFI-06T10C-SB

* For tube length > 80mm and ACR > 3000g, we preconise using adapter AFI-06T6 or AFI-06T6ST

Tubes

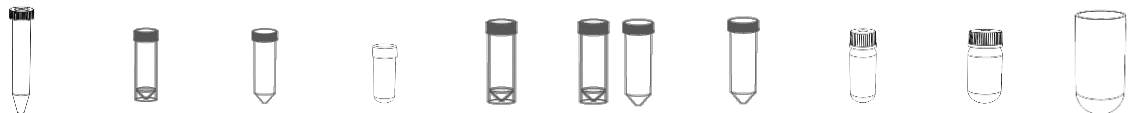

Capacity (ml)	15	30	30	30	50	50	50	50	80 / 85	100
Ø x L (mm)	17x120	25x110	25x110	25x95	29x115	29x115	29x115	29x107	38x106	44x100
Tubes per adapter / rotor	2 8	1 4	1 4	1 4	1 4	1 4	1 4	1 4	1 4	1 4
Adapter										
Hole Ø x L(mm)	18x80	26x60	26x60	26,5x70	30x70	30x70	30x70	30x70	40x78	46x90
Radius	151	150	148	147	178	149	149	150	149	149
Max charge (gr)	260									
Ref.	AFI-06T15C-SB	AFI-06T30S-SB	AFI-06T30C-SB	AFI-06T30AOR-SB	AFI-06T50S-SB	AFI-06T50CS-SB*	AFI-06T50C-SB	AFI-06T50AOR-SB	AFI-06T80AOR-SB	AFI-06T100-SB

* For protocols < 3500g

AFI RX150 + DB50

Adapters selection guide

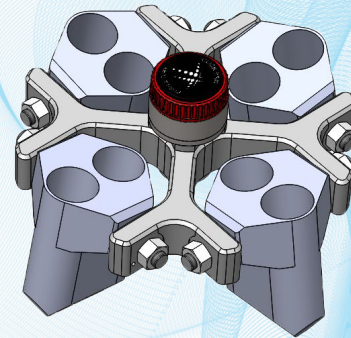

AFI-DB50 : CONICAL BUCKETS

Model	R
Max Capacity	4 x 150ml
Angle	90°
RPM Max	4 700
ACR Max	3 754

Accessories



Ref.	AFI-RXN150	AFI-B150*	AFI-L150*	AFI-SB150*	AFI-LSB150*	AFI-DB50*
------	------------	-----------	-----------	------------	-------------	-----------

* Set of 4

Tubes

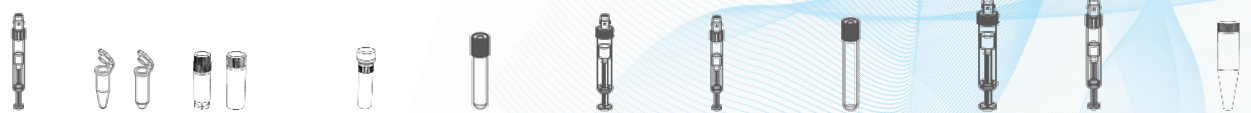

Capacity (ml)	1,1-1,4	1,5-2	1,5-2	1,3	1,6-5	2,6-4	2,7-3	5-7	4,9	4,5-5	10
Ø x L (mm)	8x82	11x38	12,5x40	10x45	13x75	13x81 91	11x82	13x100	13x106	11x108	21x90
Tubes per adapter / rotor	3 24	3 24	3 24	3 24	1 8		3 24	1 8	1 8	1 8	1 8
Adapter											
Hole Ø x L (mm)	9x50	11,25x40	13x30	11x40	13,5x58		12,5x55	13,5x78	13,5x78	12,5x80	22x80
Radius	152	131	106	96	96	124	121	124	124	141	150
Max Charge (gr)	2x67										
Ref.	AFI-50R1-2	AFI-50R2-2	AFI-50R2CRYO-2	AFI-50R1.3-2	AFI-50R5-2		AFI-50R5ST-2	AFI-50R7-2	AFI-50R7-2	AFI-50R6ST-2	AFI-50R10C-2

Tubes

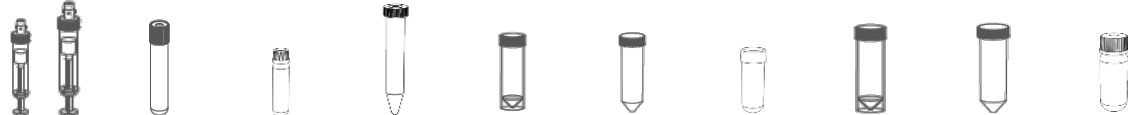

Capacity (ml)	4-8,5	7-10	10	15	30	30	30	50	50	50
Ø x L (mm)	15x91 108	16x100	16x85	17x120	25x110	25x110	25x95	29x115	29x115	29x107
Tubes per adapter / rotor	1 8		1 8	1 8	1 8	1 8	1 8	1 8	1 8	1 8
Adapter										
Hole Ø x L (mm)		17x78	17x70	18x80	26x60	26x60	26,5x70	30x70	30x70	30x70
Radius	152	134	134	152	134	140	143	134	152	142
Max Charge (gr)	2x67									
Ref.	AFI-50R10-2	AFI-50R10-OAK-2	AFI-50R15C-2	AFI-50R30S-2	AFI-50R30C-2	AFI-50R30-OAK-2	AFI-50R50S-2			AFI-50R50-OAK-2

MICROPLATES

Accessories selection guide

AFI-BHDW-150 : 8 MICROPLATES SEALED

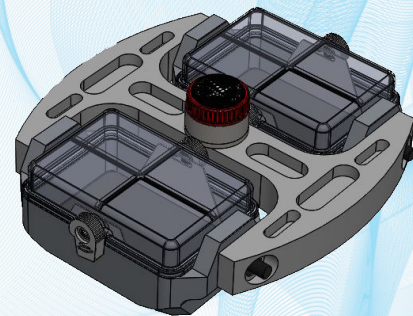

Model	R
Max Capacity	4 x 150ml
Angle	90°
RPM Max	4 700
ACR Max	2 964

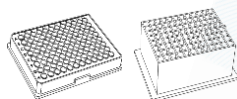

Microplate

Capacity (ml)	-	-	-	-	-
Max Height (mm)	-	-	55	55	50
Tubes per adapter / rotor	-	-	4 8	1 2	-

Accessories



Hole Ø x L (mm)	-	-	-	-
Radius	120	-	120	-
Max Charge (gr)	-	-	725	-
Ref.	AFI-RBHDW-150	AFI-RHDW-150	AFI-BHDW-150*	AFI-LH-150*

* Set of 2

CYTOLOGY

Accessories selection guide

Model	V
Max Capacity	12 Funnels
Angle	90°
RPM Max	2 000
ACR Max	438

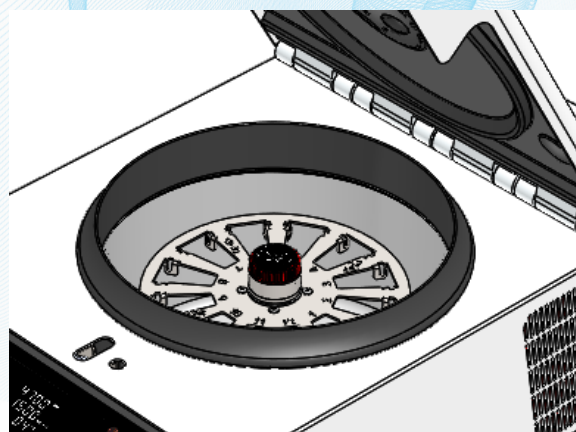



Accessories





Ref.	AFI-RCYTO
------	-----------

EZ CYTOFUNNEL

PACKS	DOUBLE	DOUBLE	SINGLE	SINGLE	SINGLE
Capacity (mL)	0,5	0,5	0,5	0,5	0,5
Surface (mm ²)	28	28	28	28	28
∅ (mm)	6	6	6	6	6
Description					
Radius	98				
Set of	200	40	200	40	40
Ref.	AFI-EZ-DFWC-200	AFI-EZ DFWC-40	AFI-EZ-SFWC-200	AFI-EZ-SFWC-40	AFI-EZ-SFBC-40

INDIVIDUAL SOLUTIONS

	CLIP	CLIP
Description		
Set of	6	50
Ref.	AFI-CLIP-M	AFI-CLIP-P



DOUBLE	DOUBLE	SINGLE	SINGLE	SINGLE
0,5	0,5	0,5	0,5	0,4
28	28	28	28	28
6	6	6	6	6
				
500	25	500	50	500
AFI-DFW-500	AFI-DFW-25	AFI-SFW-500	AFI-SFW50	AFI-SFB-50

FIXED ANGULAR ROTORS



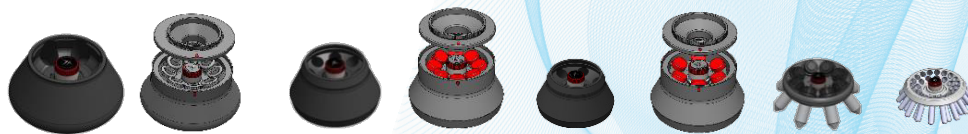



Accessories selection guide

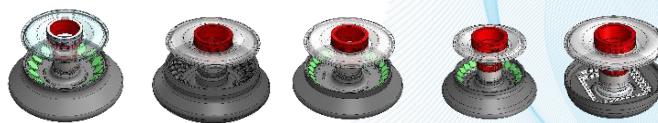

SIRENA ACCESSORIES			AFI-RA6-100	AFI-RA8-100L	AFI-RA8-50	AFI-RA8-50L	AFI-RA6-50	AFI-RA6-50L	AFI-FA8-50	AFI-RA30-15	
Max Capacity (ml)			6x100	8x100	8x50	8x50	6x50	6x50	8x50	30x15	
Max Speed (rpm)			7 000	7 000	7 500	7 500	9 500	12 000	5 600	4 700	
Max RCF (g)			5 807	5 807	6 415	6 415	10 292	16 421	4 944	3 482	
Lid				✓		✓		✓	✓		
LISA Compatible*			✓	✓	✓	✓			✓	✓	
Acc Dec (s)							40 45				
* Compatible with the maximum speed written above the rotor.											
Tubes	ml	Ø x L									
	1,1-1,4	8x82	12	16	24	24	18	18	24	-	
	1,5-2	11x38	24	32	24	24	18	18	24	-	
	1,5-2	12,5x40	24	32	24	24	18	18	24	-	
	1,3	10x45	30	40	24	24	18	18	24	-	
	1,6-5	13x75	12	16	8	8	6	6	8	30	
	5-7	13x100	12	16	8	8	6	6	8	-	
	2,6-4,9	13x81-106	12	16	8	8	6	6	8	-	
	1,2-5	11x82-108	12	40	8	8	6	6	8	-	
	4-8,5	15x91-108	12	16	8	8	6	6	8	-	
	7-10	16x100	12	16	8	8	6	6	8	30	
	10 OAK	16x85	6	8	8	8	6	6	8	-	
	10	21x90	6	8	8	8	6	6	8	-	
	15	17x120	6	8	8	8	6	6	8	30	
	30	25x110	6	8	8	8	6	6	8	-	
	30	25x110	6	8	8	8	6	6	8	-	
	30 OAK	25x95	6	8	8	8	6	6	8	-	
	50	29x115	6	8	8	8	6	6	8	-	
	50 OAK	29x107	6	8	8	8	6	6	8	-	
	80 OAK 85 OAK	38x106	6	8	-	-	-	-	-	-	





SIRENA ACCESSORIES			AFI-RA16-5	AFI-RA48-2	AFI-RA30-2	AFI-RA24-2	AFI-RAPCR8-8
Max Capacity (ml)			16x5	48x2	30x2	24x2	8x8
Max Speed (rpm)			14 200	12 700	14 000	18 000	15 000
Max RCF (g)			24 347	18 213	21 694	31 514	16 099
Lid			✓	✓	✓	✓	✓
LISA Compatible*			✓	✓	✓	✓	
				52 68		33 38	
* Compatible with the maximum speed written above the rotor.							
Micro Tubes	ml	∅ x L					
	0,2-0,25	6x18	-	48	30	24	
	0,5	8x30	-	48	30	24	
	1,5-2	11x38	-	48	30	24	
	5	16,5x60	16	-	-	-	-
	2 SPIN COLUMN	11x38	16	-	-	24	-
	8x8	6x22	-	-	-	-	8

FIXED ANGULAR ROTORS

Accessories selection guide



Angular rotor 6x100ml - 28°

Model	R
Max Capacity	6x 100mL
Angle	28°
RPM Max	7 000
ACR Max	5 807



Accessories



Ref.	AFI-RA6-100
------	-------------

Tubes										
Capacity (ml)	1,1-1,4	1,5-2	1,5-2	1,3	1,6-5	2,6-4	2,7-3	5-7	4,9	4,5-5
∅ x L (mm)	8x82	11x38	12,5x40	10x45	13x75	13x81 91	11x82	13x100	13x106	11x108
Tubes per adapter / rotor	2 12	4 24	4 24	5 30	2 12		5 30	2 12		1 6
Adapter										
Hole ∅ x L(mm)	9x50	11,25x40	13x30	11x40	13,5x58		12,5x55	13,5x78		12,5x80
Radius 106	87 103	83 104	83 104	90 110	87 103		89 111	87 103		108
Ref.	AFI-100R1-2	AFI-100R2-2	AFI-100R2CRYO-	AFI-100R1.3-2	AFI-100R5-2		AFI-100R5ST-2	AFI-100R7-2		AFI-100R6ST-2

Tubes										
Capacity (ml)	10	4-5	7-10	5-8	10	15	30	30	30	50
∅ x L (mm)	21x90	15x91	16x100	15x108	16x85	17x120	25x110	25x110	25x95	29x115
Tubes per adapter / rotor	1 6	2 12		1 6	1 6	1 6	1 6	1 6	1 6	1 6
Adapter										
Hole ∅ x L(mm)	22x80	17x78		17x80	17x70	18x80	26x60	26x60	26,5x70	30x70
Radius 106	95	87 103		107	87 103	95	96	96	94	101
Ref.	AFI-100R10C-2	AFI-100R10-2		AFI-100R10ST-2	AFI-100R10-OAK-2	AFI-100R15C-2	AFI-100R30S-2	AFI-100R30C-2	AFI-100R30-OAK-	AFI-100R50C-2

Tubes			
Capacity (ml)	50	80	85
∅ x L (mm)	29x107	38x106	38x106
Tubes per adapter / rotor	1 6	1 6	
Adapter			
Hole ∅ x L(mm)	30x70	39x68	
Radius 106	98	103	
Ref.	AFI-100R50-OAK-	-	-



Angular rotor 8x100ml - 28° - Sealed

Model	R
Max Capacity	8x 100mL
Angle	28°
RPM Max	7 000
ACR Max	5 807

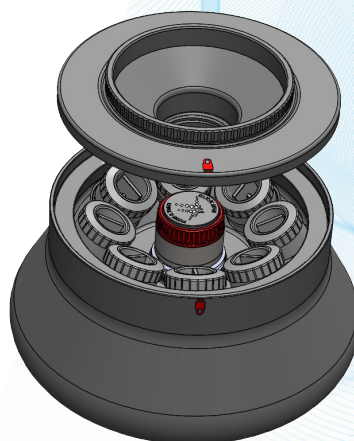

Visual LOCK for PERFECT lid closure



Accessories

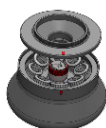

Ref.	AFI-RA8-100L
------	--------------

Tubes

Capacity (ml)	1,1-1,4	1,5-2	1,5-2	1,3	1,6-5	2,6-4	2,7-3	5-7	4,9	4,5-5
∅ x L (mm)	8x82	11x38	12,5x40	10x45	13x75	13x81 91	11x82	13x100	13x106	11x108
Tubes per adapter / rotor	2 12	4 24	4 24	5 30	2 12		5 30	2 12		1 6
Adapter										
Hole ∅ x L (mm)	9x50	11,25x40	13x30	11x40	13,5x58		12,5x55	13,5x78		12,5x80
Radius	106	87 103	83 104	90 105	87 103		89 105	87 103		108
Ref.	AFI-100R1-2	AFI-100R2-2	AFI-100R2CRYO-2	AFI-100R1.3-2	AFI-100R5-2		AFI-100R5ST-2	AFI-100R7-2		AFI-100R6ST-2

Tubes

Capacity (ml)	10	4-5	7-10	5-8	10	15	30	30	30	50
∅ x L (mm)	21x90	15x91	16x100	15x108	16x85	17x120	25x110	25x110	25x95	29x115
Tubes per adapter / rotor	1 6	2 12		1 6	1 6	1 6	1 6	1 6	1 6	1 6
Adapter										
Hole ∅ x L (mm)	22x80		17x78	17x80	17x70	18x80	26x60	26x60	26,5x70	30x70
Radius	106	95	87 103	107	87 103	95	96	96	94	101
Ref.	AFI-100R10C-2	AFI-100R10-2		AFI-100R10ST-2	AFI-100R10-OAK-2	AFI-100R15C-2	AFI-100R30S-2	AFI-100R30C-2	AFI-100R30-OAK-	AFI-100R50C-2

Tubes

Capacity (ml)	50	80	85
∅ x L (mm)	29x107	38x106	38x106
Tubes per adapter / rotor	1 6	1 6	
Adapter			
Hole ∅ x L (mm)	30x70	39x68	
Radius	106	103	
Ref.	AFI-100R50-OAK-2	-	

FIXED ANGULAR ROTORS

Accessories selection guide



Angular rotor 8x50ml - 25°

Model	R
Max Capacity	8x 50mL
Angle	25°
RPM Max	7 500
ACR Max	6 415



Accessories



Ref.	AFI-RA8-50
------	------------

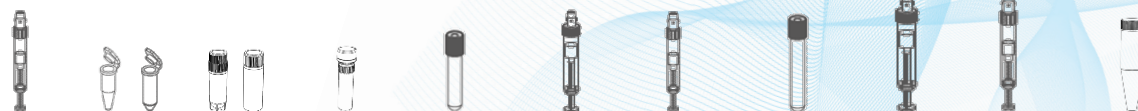

Tubes

Capacity (ml)	1,1-1,4	1,5-2	1,5-2	1,3	1,6-5	2,6-4	2,7-3	5-7	4,9	4,5-5	10
∅ x L (mm)	8x82	11x38	12,5x40	10x45	13x75	13x81 91	11x82	13x100	13x106	11x108	21x90
Tubes per adapter / rotor	3 24	3 24	3 24	3 24	1 8		3 24	1 8	1 8	1 8	1 8

Adapter

Hole ∅ x L (mm)	9x50	11,25x40	13x30	11x40	13,5x58	12,5x55	13,5x78	13,5x78	12,5x80	22x80
Radius	102	83 97	74 88	71 85	69 82	87	80 90	95	95	95
Ref.	AFI-50R1-2	AFI-50R2-2	AFI-50R2CRYO-2	AFI-50R1.3-2	AFI-50R5-2	AFI-50R5ST-2	AFI-50R7-2	AFI-50R7-2	AFI-50R6ST-2	AFI-50R10C-2

Tubes

Capacity (ml)	4-8,5	7-10	10	15	30	30	30	50	50
∅ x L (mm)	15x91 108	16x100	16x85	17x120	25x110	25x110	25x95	29x115	29x107
Tubes per adapter / rotor	1 8		1 8	1 8	1 8	1 8	1 8	1 8	1 8

Adapter

Hole ∅ x L (mm)	17x78	17x70	18x80	26x60	26x60	26,5x70	30x70	30x70
Radius	102	95	85	97	99	95	98	102
Ref.	AFI-50R10-2	AFI-50R10-OAK-2	AFI-50R15C-2	AFI-50R30S-2	AFI-50R30C-2	AFI-50R30-OAK-2	-	AFI-50R50-OAK-

Angular rotor 8x50ml - 25° - Sealed

Model	R
Max Capacity	8x 50mL
Angle	25°
RPM Max	7 500
ACR Max	6 415

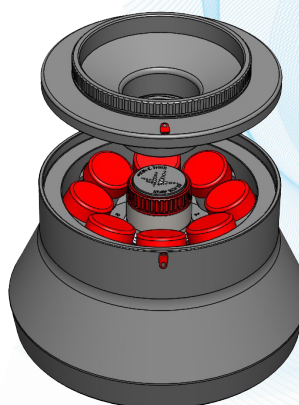

Visual LOCK for PERFECT lid closure



Accessories



Ref.	AFI-RA8-50L
------	-------------

Tubes

Capacity (ml)	1,1-1,4	1,5-2	1,5-2	1,3	1,6-5	2,6-4	2,7-3	5-7	4,9	4,5-5	10
∅ x L (mm)	8x82	11x38	12,5x40	10x45	13x75	13x81 91	11x82	13x100	13x106	11x108	21x90
Tubes per adapter / rotor	3 24	3 24	3 24	3 24	1 8		3 24	1 8	1 8	1 8	1 8

Adapter

Hole ∅ x L (mm)	9x50	11,25x40	13x30	11x40	13,5x58		12,5x55	13,5x78	13,5x78	12,5x80	22x80
Radius	83 97	74 88	71 85	69 82	87		80 90	95	95	95	95
Ref.	AFI-50R1-2	AFI-50R2-2	50R2CRYO-2	AFI-50R1.3-2	AFI-50R5-2		AFI-50R5ST-2	AFI-50R7-2	AFI-50R7-2	AFI-50R6ST-2	AFI-50R10C-2

Tubes

Capacity (ml)	4-8,5	7-10	10	15	30	30	30	50	50
∅ x L (mm)	15x91 108	16x100	16x85	17x120	25x110	25x110	25x95	29x115	29x107
Tubes per adapter / rotor	1 8		1 8	1 8	1 8	1 8	1 8	1 8	1 8

Adapter

Hole ∅ x L (mm)	17x78		17x70	18x80	26x60	26x60	26,5x70	30x70	30x70
Radius	95		85	97	99	95	98	102	#REF!
Ref.	AFI-50R10-2		AFI-50R10-OAK-2	AFI-50R15C-2	AFI-50R30S-2	AFI-50R30C-2	AFI-50R30-OAK-	-	AFI-50R50-OAK-

FIXED ANGULAR ROTORS

Accessories selection guide

Angular rotor 6x50ml - 25°

Model	R
Max Capacity	6x 50mL
Angle	25°
RPM Max	9 500
ACR Max	10 292



Accessories













Ref.	AFI-RA6-50
------	------------



Tubes

Capacity (ml)	1,1-1,4	1,5-2	1,5-2	1,3	1,6-5	2,6-4	2,7-3	5-7	4,9	4,5-5	10
∅ x L (mm)	8x82	11x38	12,5x40	10x45	13x75	13x81 91	11x82	13x100	13x106	11x108	21x90
Tubes per adapter / rotor	3 18	3 18	3 18	3 18	1 6		3 18	1 6	1 6	1 6	1 6

Adapter

										
Hole ∅ x L(mm)	9x50	11,25x40	13x30	11x40	13,5x58	12,5x55	13,5x78	13,5x78	12,5x80	22x80
Radius	85 99	76 90	72 87	70 84	89	81 95	97	97	97	97
Ref.	AFI-50R1-2	AFI-50R2-2	50R2CRYO-2	50R1.3-2	AFI-50R5-2	AFI-50R5ST-2	AFI-50R7-2	AFI-50R7-2	AFI-50R6ST-2	AFI-50R10C-2

Tubes

Capacity (ml)	4-8,5	7-10	10	15	30	30	30	50	50
∅ x L (mm)	15x91 108	16x100	16x85	17x120	25x110	25x110	25x95	29x115	29x107
Tubes per adapter / rotor	1 6		1 6	1 6	1 6	1 6	1 6	1 6	1 6

Adapter

							
Hole ∅ x L(mm)	17x78	17x70	18x80	26x60	26x60	26,5x70	30x70
Radius	97	87	89	101	97	100	102
Ref.	AFI-50R10-2	AFI-50R10-OAK-2	AFI-50R15C-2	AFI-50R30S-2	AFI-50R30C-2	AFI-50R30-OAK-2	AFI-50R50-OAK-



Angular rotor 6x50ml - 25° - Sealed

Model	R
Max Capacity	6x 50mL
Angle	25°
RPM Max	12 000
ACR Max	16 421

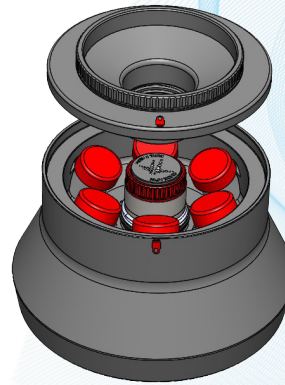

















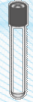









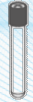



Visual LOCK for PERFECT lid closure

































Accessories

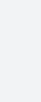

Ref.	AFI-RA6-50L
------	-------------

											
Tubes											
Capacity (ml)	1,1-1,4	1,5-2	1,5-2	1,3	1,6-5	2,6-4	2,7-3	5-7	4,9	4,5-5	10
∅ x L (mm)	8x82	11x38	12,5x40	10x45	13x75	13x81 91	11x82	13x100	13x106	11x108	21x90
Tubes per adapter / rotor	3 18	3 18	3 18	3 18	1 6		3 18	1 6	1 6	1 6	1 6
Adapter											
Hole ∅ x L (mm)	9x50	11,25x40	13x30	11x40	13,5x58		12,5x55	13,5x78	13,5x78	12,5x80	22x80
Radius	102	85 99	76 90	72 87	70 84	89	81 95	97	97	97	97
Ref.	AFI-50R1-2	AFI-50R2-2	AFI-50R2CRYO-2	AFI-50R1.3-2	AFI-50R5-2		AFI-50R5ST-2	AFI-50R7-2	AFI-50R7-2	AFI-50R6ST-2	AFI-50R10C-2

										
Tubes										
Capacity (ml)	4-8,5	7-10	10	15	30	30	30	50	50	
∅ x L (mm)	15x91 108	16x100	16x85	17x120	25x110	25x110	25x95	29x115	29x107	
Tubes per adapter / rotor	1 6		1 6	1 6	1 6	1 6	1 6	1 6	1 6	
Adapter										
Hole ∅ x L (mm)	17x78	17x70	18x80	26x60	26x60	26,5x70	30x70	30x70	30x70	
Radius	102	97	87	89	101	97	100	102	102	
Ref.	AFI-50R10-2	AFI-50R10-OAK-2	AFI-50R15C-2	AFI-50R30S-2	AFI-50R30C-2	AFI-50R30-OAK-2	-	-	AFI-50R50-OAK-	

FIXED ANGULAR ROTORS

Accessories selection guide

Angular rotor 8x50ml - 40° - Sealed

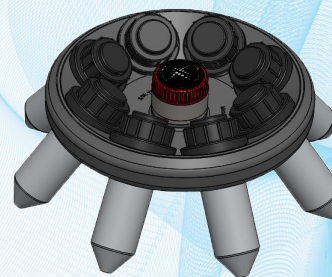

Model	R
Max Capacity	8x 50mL
Angle	40°
RPM Max	5 600
ACR Max	4 944

Accessories



Ref.	AFI-FA8-50
------	------------

Tubes											
Capacity (ml)	1,1-1,4	1,5-2	1,5-2	1,3	1,6-5	2,6-4	2,7-3	5-7	4,9	4,5-5	10
Ø x L (mm)	8x82	11x38	12,5x40	10x45	13x75	13x81 91	11x82	13x100	13x106	11x108	21x90
Tubes per adapter / rotor	3 24	3 24	3 24	3 24	1 8		3 24	1 8	1 8	1 8	1 8
Adapter											
Hole Ø x L(mm)	9x50	11,25x40	13x30	11x40	13,5x58		12,5x55	13,5x78	13,5x78	12,5x80	22x80
Radius	141	122 136	113 127	110 124	126		119 132	134	134	134	134
Ref.	AFI-50R1-2	AFI-50R2-2	AFI-50R2CRYO-2	AFI-50R1.3-2	AFI-50R5-2		AFI-50R5ST-2	AFI-50R7-2	AFI-50R7-2	AFI-50R6ST-2	AFI-50R10C-2

Tubes									
Capacity (ml)	4-8,5	7-10	10	15	30	30	30	50	50
Ø x L (mm)	15x91 108	16x100	16x85	17x120	25x110	25x110	25x95	29x115	29x107
Tubes per adapter / rotor	1 8		1 8	1 8	1 8	1 8	1 8	1 8	1 8
Adapter									
Hole Ø x L(mm)	17x78		17x70	18x80	26x60	26x60	26,5x70	30x70	30x70
Radius	134		124	136	138	134	137	141	140
Ref.	AFI-50R10-2		AFI-50R10-OAK-2	AFI-50R15C-2	AFI-50R30S-2	AFI-50R30C-2	AFI-50R30-OAK-	-	AFI-50R50-OAK-

Ideal for your sensitive samples.
 Sealed and individually removable adapters.
 Guaranteed safety throughout your analysis protocol, before, during and after centrifugation

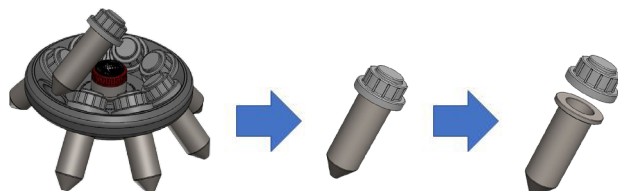





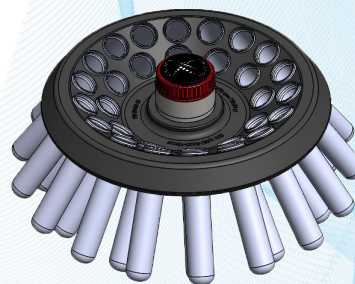

Angular rotor 30x15ml - 37°

Model	R
Max Capacity	30x 15mL
Angle	37°
RPM Max	4 700
ACR Max	3 482



Tubes



							
Capacity (ml)	-	5	1,6-5	5-7	10	14	15
∅ x L (mm)	-	12x75	13x75	13x100	16x100	17x100	17x120
Tubes per adapter / rotor	-	1 30	1 30	1 30	1 30	1 30	1 30
Accessories							
Hole ∅ x L(mm)	18x98	13,5x78	13,5x78	17x78	17x78	18x98	18x98
Radius	122 141	96 115	96 115	110 129	110 129	118 136	118 136
Ref.	AFI-RA30-15						

Angular rotor PCR8x8ml - 60° - Sealed

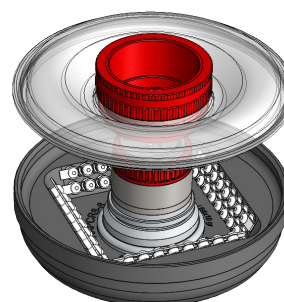
Model	R
Max Capacity	8x PCR
Angle	60°
RPM Max	15 000
ACR Max	16 099



Tubes

	
Capacity (ml)	8x0,2
∅ x L (mm)	6x22
Tubes per adapter / rotor	8
Accessories	
Hole ∅ x L(mm)	6,2x16,5
Radius	60 64
Ref.	AFI-RAPCR8-8

FIXED ANGULAR ROTORS

Accessories selection guide

Angular rotor 16x5ml - 45° - Sealed

Model	R
Max Capacity	16x 5mL
Angle	45°
RPM Max	14 200
ACR Max	24 347

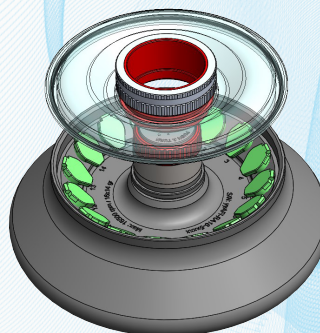

Tubes

	5	0,2	0,25	0,5	2	SPIN-COLUMNS
Capacity (ml)	5	0,2	0,25	0,5	2	2
∅ x L (mm)	16,5x60	6x18	7x39	8,3x39	11x38	11x38
Tubes per adapter / rotor	16	1 16	1 16	1 16	1 16	1 16

Accessories

Hole ∅ X L(mm)	17x57	79	7x39	8,3x39	11,2x41	11,2x39
Radius	108	79	80	82	95	95
Ref.	AFI-RA16-5	AFI-5R02*	AFI-5R025*	AFI-5R05	AFI-5R2	AFI-5R2SC

* Set of 8

Angular rotor 48x2ml - 45° - Sealed

Model	R
Max Capacity	48x 2mL
Angle	45°
RPM Max	12 700
ACR Max	18 213

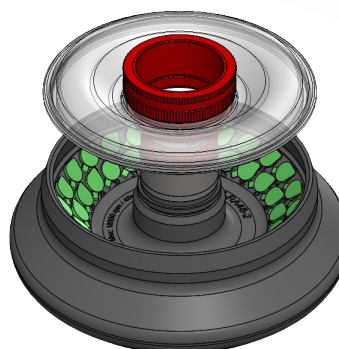

Tubes

	1,5-2	2	0,2	0,25	0,5	1,5-2
Capacity (ml)	1,5-2	2	0,2	0,25	0,5	1,5-2
∅ x L (mm)	11x38	11x38	6x18	7x39	8x30	11x38
Tubes per adapter / rotor	48	48	1 48	1 48	1 48	48

Accessories

Hole ∅ X L(mm)	11,2x41	89 99	7x39	8,3x39	11,2x41
Radius	91 101	89 99	89 99	89 99	91 101
Ref.	AFI-RA48-2	AFI-2R02*	AFI-2R025*	AFI-2R05*	AFI-RA48-2 NUNC

* Set of 6

Available for NUNC tubes



Angular rotor 30x2ml - 45° - Sealed

Model	R
Max Capacity	30x 2mL
Angle	45°
RPM Max	14 000
ACR Max	21 694

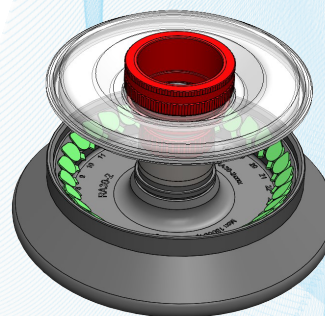

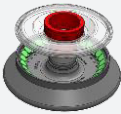
Tubes	SPIN COLUMN				
	1,5-2	2	0,2	0,25	0,5
Capacity (ml)	1,5-2	2	0,2	0,25	0,5
∅ x L (mm)	11x38	6x18	6x18	8x30	8x30
Tubes per adapter / rotor	30	1 30	1 30	1 30	1 30
Accessories					
Hole ∅ x L (mm)	11,2x41	7x39	7x39	8,3x39	8,3x39
Radius	99	97	97	97	97
Ref.	AFI-RA30-2	AFI-2R02*	AFI-2R025*	AFI-2R05*	AFI-2R05*

* Set of 6

Angular rotor 24x2ml - 45° - Sealed

Model	R
Max Capacity	24x 2mL
Angle	45°
RPM Max	18 000
ACR Max	31 514

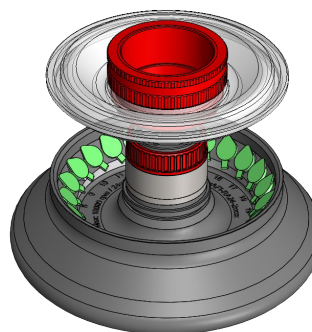

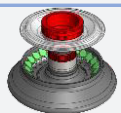
Tubes	SPIN COLUMN				
	1,5-2	2	0,2	0,25	0,5
Capacity (ml)	1,5-2	2	0,2	0,25	0,5
∅ x L (mm)	11x38	6x18	6x18	8x30	8x30
Tubes per adapter / rotor	24	1 48	1 48	1 48	1 48
Accessories					
Hole ∅ x L (mm)	11,2x41	7x39	7x39	8,3x39	8,3x39
Radius	87	85	85	85	85
Ref.	AFI-RA24-2	AFI-2R02*	AFI-2R025*	AFI-2R05*	AFI-2R05*

* Set of 6



	SMALL	MEDIUM	LARGE
Ref.	AFI-MT550	AFI-MT750	AFI-MT850
Dimensions wxhxd (mm)	550x560x700	750x560x700	850x560x700
	2 tiroirs, 4 roulettes avec frein / 2 drawers, 4 wheels with brake		
LINA V	✓		
LINA R	✓		
ISA V	✓		
ISA R	✓		
SIRENA	✓		
LISA V	✓		
LISA R		✓	
LOREENA V		✓	
LOREENA R			✓

We offer you a range of AFI furniture dedicated to your centrifuges.





These furniture have been designed to last.
They are reinforced with a metal frame to ensure robustness.





They are equipped with 4 castors with brakes for more mobility and flexibility in your laboratory.

The large drawers allow you to place all your accessories.

These furniture are for you !



Spécifications - Specifications			
Modèle - Model		Réfrigéré - Refrigerated	
Centrifugeuse de paillasse <i>Benchtop centrifuge</i>			
Référence - Reference		AFI-C060R-E	AFI-C060R-E/IVD
Tension nominale - Nominal voltage (+/- 10%)		230 V	
Fréquence - Frequency		50 Hz	
Puissance alimentation max. - Power max.		1100 W (460 W compressor)	
Tension nominale - Nominal voltage (+/- 10%)		120 V	
Fréquence - Frequency		60 Hz	
Puissance alimentation max. - Power max.		1100 W (460 W compressor)	
Conformité aux directives Européennes - Compliance with European directives			
(UE)2017/746: Dispositifs médicaux de diagnostic in vitro <i>In vitro diagnostic medical devices</i>		✓	✓
2014/35/UE : Directive Basse Tension – Low Voltage Directive		✓	✓
2014/30/UE : Directive CEM - EMC directive		✓	✓
2012/19/CE : Directive DEEE - WEEE directive		✓	✓
2011/65/CE : Directive ROHS - ROHS Directive		✓	✓
IEC / EN61010-1 (2010) : Sécurité - Safety		✓	✓
IEC / EN61010-2-020 (2006) : Sécurité - Safety		✓	✓
IEC / EN61010-2-101 (2015) : Sécurité - Safety		✓	✓
EN61326-1(2013) : Compatib. électromagn. - EMC compatibility		✓	✓
EN55011 2009/A1 (2010) Classe A : Perturbations / Emissions		✓	✓
EN ISO 14971 (2012) : Gestion des risques - Risk management		✓	✓
ISO 9001 (2015) : Gestion des risques - Risk management		✓	✓
ISO 13485 (2016) : Gestion des risques - Risk management		✓	✓
Caractéristiques principales (voir brochure) - Main specifications (see brochure for full specification)			
Rotors Swing-out <i>Swing-out rotors</i> 	Capacité max. <i>Max. capacity</i>	Rotor AFI-RX150 Bucket AFI-BX150	4 x 150 ml
	RPM max.		4 700 rpm
	ACR max <i>Max. RCF</i>		3 704 g
Rotors Microplaques <i>Microplate rotors</i> 	Capacité max. <i>Max. capacity</i>	Rotor AFI-RHDW-150 Bucket AFI-BHDW-150	2x4 microplaques <i>2x4 microplates</i>
	RPM max.		4 700 rpm
	ACR max <i>Max. RCF</i>		2 964 g
Rotors Angulaires <i>Fixed angle rotors</i> 	Capacité max. <i>Max. capacity</i>	Rotor AFI-RA8-100	8 x 100 ml
	RPM max.	Rotor AFI-RA24-2	18 000 rpm
	ACR max <i>Max. RCF</i>		31 514 g
Couvercle - Lid		✓	
Dimensions & poids - Dimensions & Weight			
Dimensions (HxLxL) - Foot print Dimensions (HxWxD)		29 x 44 x 72 cm	
Profondeur table – Table deep		65 cm	
Dimensions emballage (HxLxL) - Package dimension (HxWxD)		47 x 52 x 81 cm	
Hauteur couvercle ouvert - Opened lid height		72 cm	
Poids net - Weight unpacked		70 Kg	
Poids emballé - Weight packed		80 kg	

Description de la centrifugeuse / Centrifuge description		
Référence - Reference	AFI-C060R-E	AFI-C060R
Écran LCD 4.7" 4.7" LCD screen		✓
Commandes Commands		Touches tactiles Tactiles Buttons
Contrôle par microprocesseur Microprocessor control		✓
Fixation de rotor sans outil Toolless rotor fixing		Système "ClickSpin®"
Reconnaissance automatique du rotor Automatic rotor recognition		✓
Détection de balourd Imbalance detection		Calibration ajustable (15g swing out et 3g rotors angulaires). Neutralisation automatique des vibrations liées à l'environnement. Tunable calibration (15g for swing out & 3g for angular rotors). Automatic neutralization of vibrations due to environment
Mode économie d'énergie Energy saving mode		Mode "Postcool" désactivable Desactivable "Postcool" mode
Fermeture du couvercle Lid closing		Fermeture manuelle & ouverture motorisée Manual closing & motorized opening
Durées de cycle Cycle duration		10 s à 99h:59min:59s & Impulsion 10 s to 99h:59min:59 s & Pulse
Unités de température Temperature units		°C / °F
Chambre de centrifugation Centrifugation chamber		Inox
Densité max. Max. density		1.2 g / cm ³
Moteur à induction sans charbon Brushless induction motor		✓
Vitesse mini / Maxi Mini / Max Speed		170 Rpm/ 18 000 Rpm – 5x g /31 514 x g
Pas de réglage de la vitesse Speed setting step		10 rpm – 10x g
Précision de vitesse Speed accuracy		± 0.5%
Nombre de programmes Programs number		99+2
Fonction Pulse Pulse (short run)		✓
Pentes d'accélération & de freinage Acceleration & Braking slopes		10 & 10
Décélération libre Brakeless mode		✓
Système de réfrigération Cooling system		Sans CFC CFC free
Plage de réglage en température Range of setting temperature		-10°C → +40°C
Fonction de pré-refroidissement Precool function		✓
Précision en température Temperature accuracy		+/- 2°C
Dissipation de chaleur maximale Heat dissipation		3 753 BTU/h
Niveau sonore max. Max. noise		≤ 54 dB(A)



M A D E I N F R A N C E

AFI Groups

3 Rue Nicolas Copernic - 53200 Château Gontier - France

Tel. +33 2 43 06 15 19

<http://www.afigroups.com>

e-mail: contact@afigroups.com

*Scan me to discover
AFI catalogs*



* If necessary or useful without affecting the essential characteristics of a model, the technical and stylistic characteristics may be modified without prior notice from the manufacturer.